



Operating instructions

(Translation of the original operating instructions)

Wet separator

version "WNA"

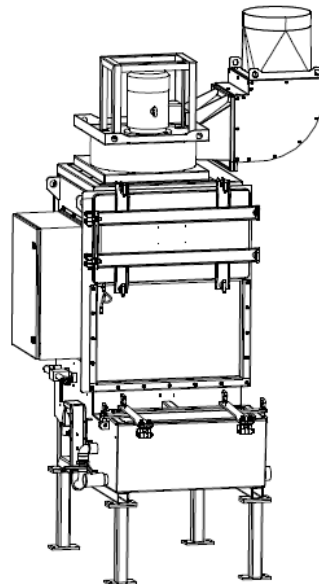



Table of contents

1. General	3
2. Description of the system elements	4
2.1. Illustration of the system elements	4
2.2. Functionality of the system	4
2.3. Intended use	5
2.4. Residual risk	5
3. Safety instructions	5
3.1. Definition of the hazard symbols	5
3.2. General safety instructions	6
4. Storage, transport and installation of the device	6
5. Commissioning	8
5.1. Connecting the suction line and exhaust air line	8
5.2. Electrical connection	9
5.3. Water supply / water quality	10
5.3.1. Additive: corrosion protection "hebro®protect 95-103" (optional)	11
5.3.2. Additive: Defoamer (optional)	11
5.4. Installing a water discharge as an overflow protection	11
6. Operating the system	12
6.1. Explanation of the operating elements	12
7. Maintenance	13
7.1. Reset to maintenance state	13
7.2. Cleaning/replacing: aluminium mesh filter and droplet separator	14
7.3. Cleaning the mud container	14
7.4. Maintenance of the magnet valves	15
7.5. Replacing the filter mats at the control cabinet	16
7.6. Cleaning the measuring hose connections	17
8. Dismantling / Disposal	18
9. Diagnostics and troubleshooting	18
10. List of spare parts	20
11. Technical data	21
12. EC declaration of conformity	22
13. Training protocol	23
14. Maintenance intervals	24
14.1. Usage-related maintenance	24
14.2. General maintenance	24
14.2.1. Visual inspection of the device	25
14.2.2. Visual inspection of the pipelines for dust deposits	25
14.2.3. Functional test of the device	26
14.2.4. Electrical test of the electrical lines and earthing connections	26
14.2.5. Test of fixing of the mounted unit elements	26

1. General

Congratulations on purchasing the product from TEKA.

Our engineers ensure that our devices reflect the state of the art through continuous development. Nevertheless, misuse or misconduct can endanger your safety. Please observe the following for a successful use of the device:

	<p>Only authorised and instructed personnel can carry out transport, operation, maintenance and repair of the device. The operator must ensure that the operating personnel take note of these instructions.</p> <p>Please read these instructions before operating the device, and observe the safety precautions to avoid injury!</p> <p>Store this manual in a safe place! These instructions are to be regarded as a component of the product!</p> <p>Adhere to all product notes!</p> <p>Modifications or conversions that the operator carries out at the device without the consent of the manufacturer, can lead to new safety hazards or to the loss of warranty claims.</p> <p>Observe the manufacturer's instructions. Contact the manufacturer in case of any uncertainty: Tel: +49 2541-84841-0 E-mail: info@teka.eu</p>
---	---

2. Description of the system elements

2.1. Illustration of the system elements

Installation example:

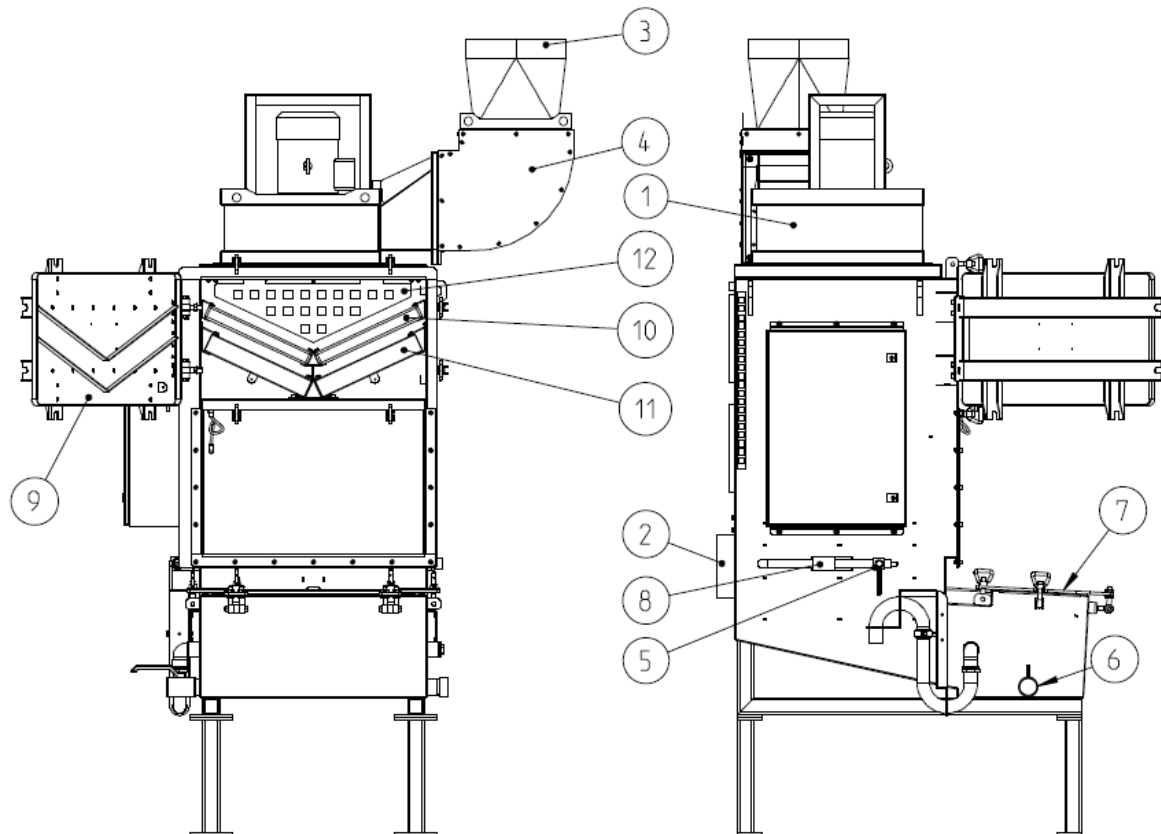

Z.Nr. 19072709

Pos.1	Fan	Pos.7	Cleaning flap
Pos.2	Suction nozzle	Pos.8	Magnet valve
Pos.3	Exhaust air nozzle	Pos.9	Service door
Pos.4	Silencer	Pos.10	Aluminium mesh filter
Pos.5	Ball valve ¾" for water connection	Pos.11	Droplet separator
Pos.6	Wastewater connection 2"	Pos.12	Protective intervention grid

2.2. Functionality of the system

The filter unit serves to suck off and filter polluted air (according to the intended use). In the filter section of the unit, the air is dragged through a water bath by means of baffle plates. The contact with water and the strong turbulences ensure that a majority of the dusts are bound in the water. The separated dust particles settle as sludge in the lower water tank. The purified air is led outside via the exhaust air pipe or back into the working room.

2.3. Intended use

The device is intended for commercial use. If the device is made publicly accessible, it must never be operated unsupervised by authorized personnel, authorized by the operator.

The filter unit is intended for extraction and filtration of grinding dusts.

	WARNING
	Improper use can damage parts and be a danger to life and limb! The device must not be used for the extraction of oil-laden welding fume, explosive dust and gases, hybrid mixtures, etc. The device must not be operated in explosive zones. <hr/> Dangers arising from fire. If the sucked medium is combustible fume or dust, the operator must determine beforehand which fire protection measures are to be taken.

2.4. Residual risk

	CAUTION
	Danger due to possible hazardous materials in the exhaust air flow. Because the unit does not monitor the quality of the air in the exhaust air flow, we recommend that you always guide the exhaust air flow exiting our unit to areas (e.g. to the outside into the open air) in which there is no danger to any living being. To do this, it is necessary to fit a suitable exhaust air line at the filter unit.

3. Safety instructions

3.1. Definition of the hazard symbols

The device is constructed according to the state of the art and the recognised safety regulations. Nevertheless, during use threats to life and limb of the user or other persons may arise. The impairment of the machine or other property are also possible. In these instructions we warn by using corresponding indications.

	WARNING
	WARNING These instructions are made in case of risks that can lead to <u>injury or death</u> .

	CAUTION
	CAUTION These instructions are made in case of risks that can lead to <u>injury</u> .

	NOTICE
	NOTICE These instructions are made in case of risks that can lead to <u>material damages</u> .



Information notes are no hazard warnings; they call attention to useful information.

3.2. General safety instructions



WARNING

Dangers arising from improper use / unauthorised operations.

The operator must ensure that their authorised personnel are familiar with all the safety indications in this manual in advance. The operator is responsible for ensuring that all work is carried out by authorised and qualified personnel. We therefore recommend using the training protocol on the last page for that purpose (see chapter "Training protocol"). Laymen are allowed to operate the device after having received the necessary instructions. But they are not allowed to carry out any installation, repair or maintenance work.

Dangers arising from fire.

In case of fire, if possible, switch the unit immediately off or disconnect it from the power supply. Fire extinguishing measures which the operator is obliged to determine beforehand must be initiated immediately.



WARNING

Dangers arising from electricity.

The operator must ensure that electrical plants and equipment are only built, modified and maintained by a qualified electrician or under the direction and supervision of a qualified electrician. Do not work on components if you are not sure that these are disconnected. If necessary, disconnect the device from the electric power supply and secure it against unauthorized restarting.

4. Storage, transport and installation of the device



WARNING

Risk of injury from tilting or unmounted components when stored or transported.

The device must be secured against tilting and slipping when it is stored or transported. Do not stand under or next to the floating load. Lift trucks, forklift trucks and transport cranes must have a sufficient minimum load bearing capacity.

Dangers arising from titling or functional impairments at its destination.

The unit may only be set up on a suitable surface. The unit may only be set up on a suitable surface. The surface must be vibration-free and horizontal. The operator must check the bearing capacity of the surface. The unit must be secured on the surface, for example using lag bolts or heavy-duty anchors.



NOTICE

Damage or functional impairment of the unit due to climatic influences.

The unit must be stored in a dry place and protected against moisture during transport. As a matter of principle, the filter unit is not designed to be installed outdoors. In this case contact the manufacturer in order to find out if a capping or a trace heating system are necessary.

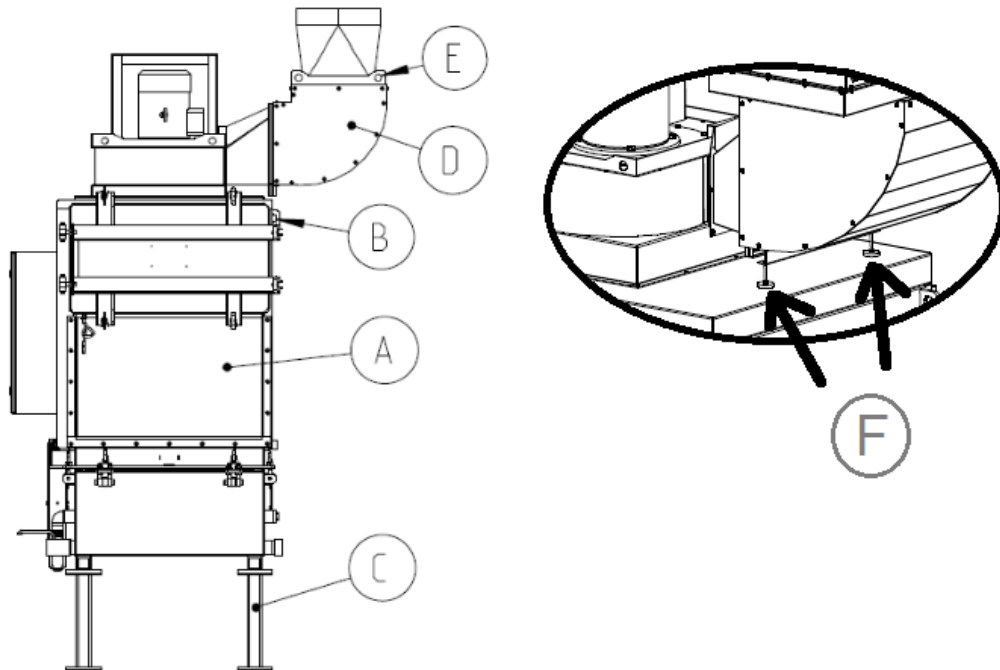

- First the filter unit as delivered must be transported to its destination. Then lift the filter unit off the pallet. Therefore use the lifting rings (B).
⚠WARNING Use appropriate lifting tools (forklift truck, transport crane,...) with a sufficient minimum load-carrying capacity. The filter unit must be secured against tilting and slipping when it is moved, lifted or put down. No one is allowed to stand under the load. Use only appropriate ladder tools.
- Optionally, the filter component (A) can be set on the supplied adjustable feet (C). This effects the future working height of the filter unit. Therefore, lift up the filter component (A) with a lifting tool for 0.5 meters.
- Mount the bow silencer (D) on the fan. Use the lifting rings (E) to lift. In doing so, also adjust the leveling feet (F) (only used for larger devices), so that the weight of the silencer is caught by the lid.
- Then the filter unit must be set up on a suitable surface at its exact intended destination. Use the lifting rings (B) to transport the filter unit there.

5. Commissioning

	WARNING
	Dangers arising from a defective condition of the unit. Make sure that the measures described in this chapter are completed before the commissioning of the unit. All doors of the unit must be closed and all necessary connections must be attached before turning the unit on. Do not operate the unit if any components are defective, missing or damaged. Check the orderly condition of the unit before switching it on. The unit must not be operated without a filter element.

	NOTICE
	Damaged supply lines. Make sure that the supply lines are protected against damage by forklift trucks and similar events. Protect all supply lines from heat, moisture, oil and sharp edges.

	If the wet separator is equipped with a frequency converter, the setting of the correct volumetric flow rate is part of the commissioning. It must be set in the control. Please refer to the instructions in the separate operating manual of the control unit.
---	--

5.1. Connecting the suction line and exhaust air line

For extracting the contaminated air, a suction line must be connected to the suction nozzle (see chapter 2.1).

	CAUTION
	Danger for the respiratory tract arising from polluted ambient air. Dust deposits in the suction pipe are possible. Only operate the system if the necessary suction line is fitted. The suction line must be dimensioned according to the application in such a way that, if possible, no dust deposits occur in the suction line. If this has not already been carried out by TEKA, a suitably qualified employee must be consulted. If the suction line includes extraction elements (e.g. suction arms, pipe grills, etc.), these must also be included in the layout. If this is the case then users must be informed of whether extraction elements can be used simultaneously and, if this is possible, then which. The regulating devices (e.g. throttle valves) of each single extraction element must also be set appropriately during the final commissioning.

If the air shall be directly sucked off by an upstream machine, the suction line must be connected to the capture opening of the upstream machine.

The exhaust air pipe must be attached to the exhaust nozzle (see chapter 2.1).

	WARNING
	Danger to life when reaching the fan impeller. The required exhaust air pipe must be attached before the commissioning.

	According to the temperature and the relative air humidity of the extracted air, the exhaust air can also be moisture. In every case, the exhaust air has to be returned outside so that the work-ing space is not too highly moisture which can lead to the formation of condensate.
---	---

5.2. Electrical connection

	WARNING
<p>Risk of electric shock. Electrical plants and equipment may only be built, modified and maintained by a qualified electrician or under the direction and supervision of a qualified electrician. Do not work on live electrical components and elements if you are not sure that these are indeed disconnected. If necessary, disconnect the device from the mains. The operator is responsible for a potential-free balance of the equipment. If the unit is equipped with a frequency converter, then it may only be operated on networks with an AC/DC sensitive RCCB. The AC/DC sensitive residual current circuit breaker (type B) must tolerate at least a permissible residual current of 100mA. For frequency converter operation, the cross section of the protective conductor</p> <ul style="list-style-type: none">• must be at least 10mm²,• and must be at least equal to the size of the operator side outer conductor cross-section.	

	NOTICE
<p>Electric malfunction possible in cause of an incorrect power supply. Pay attention to the admissible supply voltage. Please observe the specifications on the type plate.</p>	

- Mount the housing of the external control (if it is not mounted on the device itself) close to the device on the wall or at any other appropriate mounting point. Or mount the control together with a cabinet console on a suitable surface, for example using lag bolts or heavy-duty anchors.

⚠WARNING The housing is not suited for outdoor installation.

- Connect all visible cables and hoses according to their functions. When delivered they are labelled according to their functions. When connecting to the control, please observe the specifications on the circuit diagram which is attached to the control.
- Connect the unit to the power supply.
- Check if the direction of fan rotation is correct. A wrong rotation direction can be identified thanks to the sticker stuck to the fan scroll which is showing the direction. Compare the rotation direction on the sticker to the rotation direction of the motor cooling fan when the motor is running down after being switched off. If the motor rotates in the wrong direction, disconnect the device from the power supply and exchange two phases at the supply line to the control.

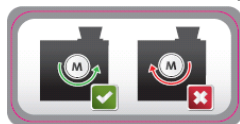

CAUTION When the fan rotates in the wrong direction, the extraction capacity is reduced.

5.3. Water supply / water quality

Due to the moistening of the outlet air, the water is little by little extracted from the filter unit. That is why water must be regularly be refilled. It is ensured by the automatic monitoring of the water level and the automatic refilling through the electrovalve.

	WARNING
<p>Danger due to unhealthy exhaust air released by contaminated water. Make sure that the supplied water is of irreproachable hygienic and microbiological quality. The supplied water must be clear, colourless and odourless. The water must also be "non-putrefactive in 5 days". Equally, in the event of a system stoppage lasting 5 or more days, the operator must check whether the water still meets the quality requirements or whether it needs to be changed. As soon as an extended stoppage of the system is envisaged, it is urgently recommended to drain off the water for this period. The operator must also make sure that the admixture of the water with the extracted dusts/fumes does not result in any interactions that jeopardize fulfilment of the above quality requirements.</p>	

	NOTICE
<p>Possible damage to equipment (valves, supply line, etc.) due to contaminated water. Make sure that the supplied water is free from suspended matter and other contaminants.</p>	

The water quality has a major impact on the functionality of the unit. It cannot always be determined in advance if an additive is necessary or not. Damages due to corrosion or improper use are therefore excluded from warranty. A regular check of the water quality (salt/lime content, degree of pollution, pH value) is essential. Please also note the information about the additives.

- During operation, the ball valve (see chapter 2.1) has to be equipped with an open water supply of 3/4".
- The wastewater connection (see chapter 2.1) is equipped with a 2" shut-off valve.
- When carrying out cleaning operations, you have to pay attention that no polluted water enters the canalisation.
- The quality of the supplied water must not affect the condition of the unit. We recommend fresh water with a pH-value of about 7.
- Before switching on the unit for the first time, it is advisable to let in water manually via the open cleaning flap (see chapter 2.1) until the water level reaches the middle of the water level indicator. The level indicator is located inside the filter housing, below the cleaning flap.



5.3.1. Additive: corrosion protection "hebro®protect 95-103" (optional)

A corrosion-protective agent should be added to the water in order to prevent the formation of rust, especially in case of separation of acidly reacting substances. This is primarily required when separating metal dust and scale dust.

If you ordered a corrosion-protective agent when ordering the unit, add it to the water when commissioning the unit.

As water is refilled from time to time, the corrosion-protective agent must be refilled in small doses as well (in case you use a corrosion-protective agent). The water consumption (see chapter "Technical data") depends on several service factors and must be observed or determined individually for each unit. For a successful use of the corrosion-protective agent it is important that it is added to the water in a mixing ratio of about 1:30 to 1:100. This can be carried out in two ways:

- manually: by refilling it regularly
- automatic dosing: by using an optional dosing device

The corrosion-protective agent and, if required, the dosing device can be ordered directly from the company Hebro Chemie: tel.: +49 2166 6009 – 0, e-mail: info@hebro-chemie.de

5.3.2. Additive: Defoamer (optional)

The defoamer releases foaming that is produced by certain types of dust. The dust bonds a certain amount of the defoamer so that it can be necessary to refill some defoamer, depending on the amount of dust. You can manually add defoamer via the $\frac{3}{4}$ " T-piece (pos. 7) (about 12,5 ml defoamer per 100 l fresh water). The exact quantity has to be determined via trials. (Defoamer is available on option).

5.4. Installing a water discharge as an overflow protection

The wet separator is equipped with a mechanical overflow protection in order to protect it from too much water supply (e.g. due to defective magnet valves). When the wet separator exceeds a certain level (B), the excess water drains off through the opening of the hose (A).



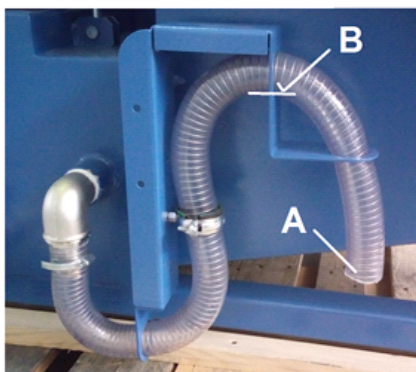

To prevent the water from spilling on the floor in case of overflowing, the operator must install a water discharge under the opening (A). The water retention can e.g. be done by a hopper. The water discharge should not be connected directly to the opening (A). Otherwise it might not be possible to recognize water leakages during a visual inspection.



6. Operating the system

6.1. Explanation of the operating elements

 Control functions, setting options for programs, menu navigation, error messages, etc. are described in the enclosed operating manual of the unit control. There is also an explanation of the elements of the control panel.

Operating elements for the device control		
Representation	Designation	Description / function
	Main switch	<ul style="list-style-type: none"> ● OFF: The device is disconnected from the power supply. ● ON: The device is connected to the power supply and ready to operate. <p> The main switch also serves as an emergency off switch.</p>
	ON-OFF-switch	<p>By means of this switch, the device is switched on and off.</p> <p> When the device is switched off, it is <u>not</u> disconnected from the power supply.</p>
	Button for manual water filling	<p>Regardless of the current fluid level, the system can be filled manually by pressing the button filling. This is however only possible when the suction unit is not running. The process is started or stopped when the button is pressed. When the valve is opened, a visual feedback is given out by the illuminated push button.</p>

Operating elements for status and error messages		
Representation	Designation	Description / function
	Signal horn	<p>Honking signals that the unit signals an error. Please refer to the error message shown on the display of the control.</p>

7. Maintenance

In accordance with national regulations, the operator is obliged to carry out repeat and functional tests. Unless otherwise specified by national regulations, we recommend regular visual inspections and functional tests of the device as described in the chapter “Maintenance intervals”.

 You find the chapter “Maintenance intervals” at the end of the document. The general maintenance (visual inspection, etc.) is also explained there.

In the chapter “Maintenance intervals” there is information on the maintenance intervals of the filter elements. But these are only recommendations. Depending on the application (multi-shift operation, dust generation, ...) it may be necessary for the operator to change the maintenance intervals.

In this chapter the maintenance work which is caused by wear caused during operation is described.

	WARNING
	<p>Work on the open system entails the risk of electrical shock or accidental restart the system. Both pose a danger to life and limb.</p> <p>When cleaning and servicing equipment during the replacement of parts or when changing to another function, set the device to maintenance condition first (see chapter “Reset to maintenance state”).</p> <p>A recommissioning of the device must only occur if it is ensured that the device is functionally equivalent to the original state.</p> <hr/> <p>Dangers to life and limb when non-original spare parts are used</p> <p>Only original TEKA spare parts must be used.</p>

	CAUTION
	<p>Hazards to the respiratory tracts are possible.</p> <p>All maintenance work must only be carried out in well-ventilated rooms and while wearing an appropriate respiratory mask! We recommend: respiratory protection half mask DIN EN 141/143 protection level P3. For all maintenance work ensure a cautious handling of filter elements and components in order to avoid whirling up dust.</p>

 The operator is obliged to store and dispose of the collected dust in accordance with national or regional regulations. For all maintenance or cleaning work please refer to the applying environmental regulations. Pollutants and filter elements must be disposed of or stored according to the regulations as well. If you have any doubts, we recommend contacting a disposal contractor in your area.

7.1. Reset to maintenance state

- Switch off the unit. Then disconnect the unit from the power supply by setting the main Switch in the “OFF” position. Secure the unit against unauthorized restarting during maintenance.



- After completion of all maintenance work the unit can be reconnected to the power supply.

7.2. Cleaning/replacing: aluminium mesh filter and droplet separator

- Open the service door (see chapter 2.1).
- Detach the grounding cable of the mesh filter and the mist eliminator (see chapter 2.1) from the housing wall. Therefore detach the protective grid, if necessary (see chapter 2.1).
- Pull the mesh filter and the mist eliminator out of the guide rail. The cleaning can be carried out with a steam ejector.

NOTICE If one of the filter elements is too heavily contaminated, it must be replaced (see list of spare parts). We recommend having filter elements in stock.

- Push the mesh filter and the mist eliminator back into the guide rail.
WARNING On reinserting, the grounding cables must be installed again! The earthing labels indicate where the grounding cables must be connected. Finally, the filter elements must be checked for electrical grounding at the housing.



- Close the service door.

7.3. Cleaning the mud container

Release the water before cleaning the mud container. In order to reduce the consumption of additives such as defoamer or especially antifreeze agents (when the wet cyclone separator is placed outside), the water supply and water outlet should be connected in order to form a closed circuit.

- Open the drain cock at the wastewater connection (see chapter 2.1).
- If the deposited mud agglutinates or clumps, the ball valve can choke from time to time. Therefore it is advisable to control if the ball valve is free in using an appropriate object (e.g. a stick) before you open the door.
- Open the cleaning flap (see chapter 2.1).
- Remove the remaining mud from the mud container with the help of a shovel.
- The interior of the container is cleaned with the help of an appropriate jet vapour. Please respect the regulations according to the protection of the environment when cleaning the container.

7.4. Maintenance of the magnet valves

The magnet valves (see chapter 2.1) must be regularly checked for their proper functioning.

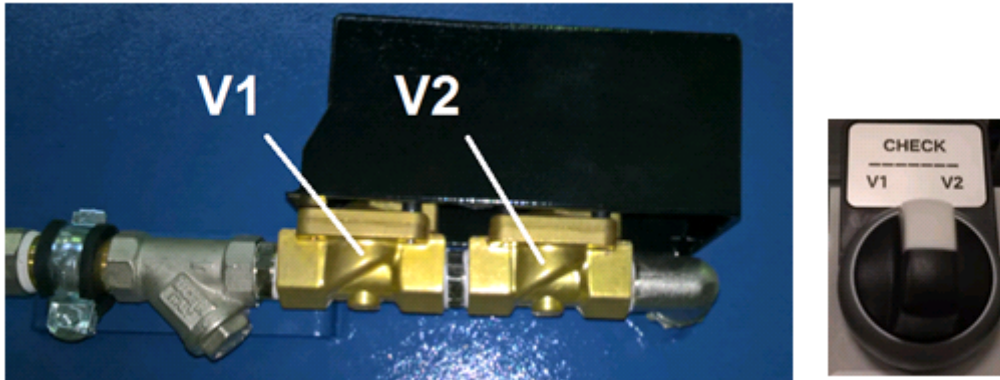

- Set the wet separator to maintenance condition. For that purpose the power supply for the control must be maintained, but the fan must be switched off. The door of the control housing must be opened.
 - ⚠ **WARNING** Working at the open control housing involves the risk of electric shock. The operator must ensure that the maintenance measures are only carried out in the presence of authorized and qualified personnel.
- Open the cleaning flap (see chapter 2.1).
- Put the maintenance switch in the position “V1”. Now check if water is still flowing in inside the wet separator.
 - NOTICE** If water is still flowing in, the magnet valve V1 (see photo) is defective and must be replaced.
- Put the maintenance switch in the position “V2”. Now check if water is still flowing in inside the wet separator.
 - NOTICE** If water is still flowing in, the magnet valve V2 (see photo) is defective and must be replaced.
- Then put the maintenance switch in the middle, neutral position.
- Close the cleaning flap.
- Close the door of the control housing.

7.5. Replacing the filter mats at the control cabinet

 This section is only relevant if the unit is equipped with a control cabinet and this is itself equipped with a filter fan and an exhaust filter.

There is a filter mat located in the louvred grille on both the filter fan and the exhaust filter. The filter mats must be checked regularly and replaced if necessary. This check depends on the level of contamination. We recommend acquiring a stock of filter mats at an early stage (see spare parts list).

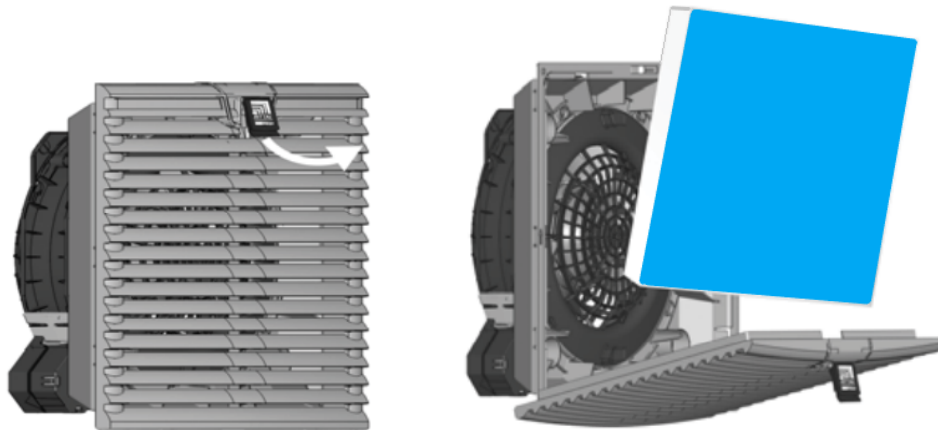

- The procedure described here must be performed at both the filter fan and the exhaust filter.
- Pull the logo in the louvred grille upwards a little using your finger. Then fold the louvred grille downwards.
- Replace the old filter mat with a new one. The blue side must face outwards.
NOTICE Only use TEKA spare filters. Otherwise the proper functioning of the unit is not guaranteed, and there is a danger to life and limb.
- Close the louvred grille until it audibly clicks into place.

7.6. Cleaning the measuring hose connections

Dust generation and the ensuing contaminations inside the device can in the long run lead to clogging of the measuring points. This would impair the functionality; the device could erroneously detect too great or too small a water volume filled.

As a prevention, we recommend regular cleaning of the two connections at the back of the device.

- Detach the blue and the black measuring hose from the connections. These can be found at the back of the device.

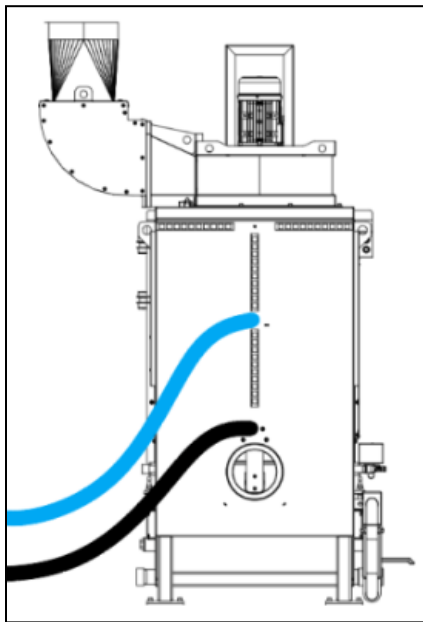

- Pierce through the two connections by means of a thick piece of wire or a long pin.





- Then re-install the two measuring hoses.

NOTICE The blue measuring hose must be installed at the top, the black measuring hose at the bottom.

8. Dismantling / Disposal

Only authorised personnel may disassemble the machine.

	WARNING
Dangers arising from electricity. Before the dismantling of the machine it has to be disconnected from the power supply and all supply lines.	

	The operator is obliged to store and dispose of the collected dust in accordance with national or regional regulations.
---	---

9. Diagnostics and troubleshooting

A list of possible system errors is provided in the table.

	Error messages of the control unit are described in the enclosed operating manual of the control unit.
	Faults indicated by control elements are explained in the chapter "Description of the control elements".

A recommissioning of the device must only occur if it is ensured that the system is functionally equivalent to the original state. Repairs may only be carried out by TEKA personnel or, after consultation with TEKA GmbH, by the personnel authorised by the operator.

Adhere to the instructions in the chapter "Safety instructions" and "Maintenance" when carrying out any repairs. If in doubt, contact our TEKA service department:

Tel: +49 2541-84841-0
E-mail: info@teka.eu

Fault	Cause	Removal
System does not start.	Plug power supply is missing or incorrectly inserted.	Plug connector check power supply / plug in correctly.
	No power at outlet.	Check the mains, remove error if possible.
Suction power too low (smoke hardly extracted).	Filter element is saturated.	Replace the filter package, dispose of old filter properly!
	Damage at the extraction elements.	Replace the extraction elements.
	The motor rotates in the wrong direction.	The rotating field of mains connection point must be changed.

	Suction line contracted.	Check and fix.
	Exhaust line contracted.	Check and fix.
	Maybe throttle valves are used in the suction line.	Adjust throttle valves.
The system is very noisy.	The motor rotates in the wrong direction.	The rotating field of mains connection point must be changed.
	There is no silencer mounted.	Mount the silencer.
	The suction line or exhaust line are not mounted.	Mount the line.
	The unit is untight.	Check and fix.
The device fills with too much or too little water.	Clogging of the measuring points.	For information on cleaning the measuring hose connections, see separate chapter.

10. List of spare parts

	WARNING
Dangers to life and limb when non-original spare parts are used. Only original TEKA spare parts must be used.	

Filter element	Article no.
Aluminium mesh filter: <i>(2 pieces of these filter elements are required for the device)</i> <ul style="list-style-type: none"> - WNA 1500 - WNA 2000 / WNA 3000 / WNA 3500 - WNA 5000 - WNA 7500 - WNA 9000 	200351500 200353500 200355000 200357500 200359000
Droplet separator: <i>(2 pieces of these filter elements are required for the device)</i> <ul style="list-style-type: none"> - WNA 1500 - WNA 2000 / WNA 3000 / WNA 3500 - WNA 5000 - WNA 7500 - WNA 9000 	20007064702xxxx 20005441706xxxx 20003061201xxxx 20006385705xxxx 20011102505xxxx
Filter mats for control cabinet <div style="text-align: right; margin-right: 20px;"> 209 x 209 mm (6 pieces) 165 x 165 mm (6 pieces) 114 x 114 mm (6 pieces) </div> <i>(required size see louvred grille on the control cabinet)</i>	100320008 100320007 100320009
Other parts	Article no.
Magnet valve, 24 V DC	9501420002

11. Technical data

Version		1500	2000	3000	3500	5000	7500	9000
Supply voltage	V	400						
Frequency	Hz	50						
Type of current	Ph	3						
Current intake	A	3,5	5,0	6,6	8,5	11,5	15,5	20,4
Air flow volume (possible operation point)	m ³ /h	1500	2000	2400	2900	5000	6500	8000
Negative pressure (possible operation point)	Pa	2400	2400	3000	3200	2600	2700	2700
Protection class		IP54						
ISO class		F						
Width	mm	850	1050	1050	1050	1250	1450	1550
Depth	mm	1160	1360	1360	1360	1560	1760	1760
Height	mm	2660	2575	2625	2635	3220	3285	3320
Sound pressure level	dB(A)	74						
Allowed ambient temperature	°C	+5 to +35 (during operations) -10 to +40 (during transport and storage)						
Allowed max. humidity	%	70						
Weight (without water filling)	kg	ca. 450	ca. 600	ca. 600	ca. 600	ca. 650	ca. 750	ca. 800
Water filling during operation	L	ca. 130	ca. 180	ca. 180	ca. 180	ca. 280	ca. 380	ca. 450
Water consumption per hour (The water consumption is dependent on flow velocity, air temperature, etc. Therefore it can vary due to the operating conditions.)	L	ca. 4	ca. 5	ca. 6	ca. 7	ca. 10	ca. 15	ca. 18
Water supply		Hose nozzle 3/4"						
Required water pressure min./max.	bar	0,3 / 16						
Extraction performance	%	> 80						

12. EC declaration of conformity

according to the Machinery Directive 2006/42/EG, Annex II, 1 A

TEKA Absaug- und Entsorgungstechnologie GmbH

Millenkamp 9, D-48653 Coesfeld

Tel.: +49 2541-84841-0

E-Mail: info@teka.eu

Internet: www.teka.eu

Designation of the device: TEKA wet separator WNA

We hereby declare under our sole responsibility that the product mentioned above, from the serial number A22600010011001 resp. P57300010011001 on, conforms to the following directives:

Machinery Directive: 2006/42/EG

Electromagnetic Compatibility: 2014/30/EC

RoHS directive: 2011/65/EU

This declaration will become void if the device is exposed to modifications that are not approved by the manufacturer in written form.

Authorized representative for the technical documentation:

TEKA Absaug- und Entsorgungstechnologie GmbH, Millenkamp 9, D-48653 Coesfeld

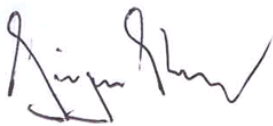

(Jürgen Kemper, managing director)

Coesfeld, 3rd January 2023



13. Training protocol

Designation of the device: TEKA wet separator WNA

(This form can be used by the operator to document the training of the employees. Training should be performed by authorized personnel only. Refer to the instructions in Chapter "Safety Instructions")

By his signature, the employee confirms that he has been instructed regarding the following items:

Instruction	completed
Description of the device	
Operation and application of the device	
Explanation of the safety instructions	
Behavior in case of fire	
Explanation of the operation elements	
Change and dedusting of the filter elements	
Appropriate disposal	
Maintenance works / Maintenance intervals	

Name of the employee (legible)	Signature

Introduction through (legible):	
Signature:	

14. Maintenance intervals

14.1. Usage-related maintenance

The described maintenances become necessary through the demands of the system operations. The maintenance intervals are recommendations. Depending on the application (multi-shift operation, dust generation, ...) it may make sense for the operator to change the intervals of maintenance, replacing and cleaning.

Maintenance work must always be documented by means of a protocol.

The approach of the maintenance measures is described in chapter "Maintenance".

Maintenance work	Chapter	Maintenance interval	
		recommended by TEKA	determined by the operator
Cleaning the aluminium mesh filter and the droplet separator	7.2	weekly	
Replacing the aluminium mesh filter		quarter-annually	
Replacing the droplet separator		annually	
Cleaning the mud container	7.3	monthly	
Maintenance of the magnet valves	7.4	quarter-annually	
Check / Replacing the filter mats at the control cabinet	7.5	semi-annually	
Cleaning the measuring hose connections	7.6	quarter-annually	

14.2. General maintenance

The described maintenances are independent from the demands of the system operations.

The operator is obliged to carry out repeated inspections and functional tests according to national regulations. If not otherwise covered by national regulations, the described maintenance intervals must be respected.

Maintenance work must always be documented by means of a protocol.

Maintenance work	Chapter	Maintenance interval
Visual inspection of the device	14.2.1	weekly
Visual inspection of the pipelines for dust deposits	14.2.2	monthly
Functional test of the device	14.2.3	monthly
Electrical test of the electrical lines and earthing connections	14.2.4	annually
Test of fixing of the mounted unit elements	14.2.5	annually

14.2.1. Visual inspection of the device

Visual inspection: Observation that there are no visible safety-related defects.

	WARNING
Danger arising from the ready to operate condition of the device. Follow the procedure as described in the chapter "Set to maintenance state".	

The following steps must be carried out in the course of the visual inspection:

- Check if all required pipeline elements, cable connections and hoses are connected to the filter unit
- Check all electrical earthing connections and cables for visible damages.
- Ensure that all parts are firmly connected.
- Check all connection points of the filter unit for escaping dust.
- Check all metal parts for corrosion or damages / changes of the coating.
- Check the inner filter area and the filter housing.
- Visual inspection of the control and operating elements as well as the outside running cables for damages.

14.2.2. Visual inspection of the pipelines for dust deposits

Visual inspection: Observation that there are no visible safety-related defects.

	WARNING
Danger arising from the ready to operate condition of the device. Follow the procedure as described in the chapter "Set to maintenance state".	

The following steps must be carried out in the course of the visual inspection:

- Open the inspection flaps of the pipeline and check the pipeline for dust deposits. Dust deposits must be eliminated.

14.2.3. Functional test of the device

	NOTICE
	<p>Possible material damage due to faulty condition of the unit. Carry out a visual inspection before the functional test of the device as described in the previous chapters. The work as described in the chapter “Commissioning” must be finished.</p>

The following steps must be carried out in the course of the functional test:

- Switch on the device.
- Pay attention to failures or error messages of the control unit. Also refer the separated operating manual of the control unit.
- Pay attention to extraneous noises or vibrations during the device’s operation.
- A functional test should always be carried out with a connected / producing machine tool. Check if the collection of the fume or dust is sufficient. (Visual inspection).

14.2.4. Electrical test of the electrical lines and earthing connections

	WARNING
	<p>Danger arising from electricity. The operator is responsible for ensuring that all work on electric components is carried out by authorised and qualified personnel.</p>

The device is subject to regular electrical checks by the operator of the device, and are subject to national standards of the different countries.

The here recommended maintenance interval complies with the in Germany applying "Regulation 3 of the German Social Accident Insurance - Electrical plants and equipment" (formerly known as BGV-A3).

The check must only be carried out by a qualified electrician or a person trained in electrics using suitable measuring and test devices. The scope of testing and the methods must be in line with the respective national standard. All contacts in the control cabinet must be checked for tight fit, and must be readjusted if necessary.

14.2.5. Test of fixing of the mounted unit elements

The following steps must be carried out in the course of the inspection:

- Make sure that all elements that are connected at or with the unit are firmly fixed in place and have not come undone or loose. These also include all air-carrying lines, all extraction elements, bearing structures and frames.
- In the case of unit elements which are subject to vibrations and/or movements, the operator may need to define a shorter maintenance interval.